



# PRIMELUB - AKCESORIA

## Elementy złączne skręcane

	<b>Przyłączka prosta na przewód d 6 mm</b>		
	Średnica przewodu	Oznaczenie przyłączki	Nr katalogowy
	6	GE 6 LL R 1/8	425000006002
	6	GE 6 LL M 6x1	425000006004
	6	GE 6 LL M 8x1	425000006006
	6	GE 6 LL M10x1	425000006008
	6	GE 6 L R 1/4	425000006009
	<b>Przyłączka prosta na przewód d 4 mm</b>		
	Średnica przewodu	Oznaczenie przyłączki	Nr katalogowy
	4	GE 4 LL R 1/8	425000006001
4	GE 4 LL M 6x1	425000006003	
4	GE 4 LL M 8x1	425000006005	
4	GE 4 LL M10x1	425000006007	
	<b>Przyłączka kątowna na przewód d 6 mm</b>		
	Średnica przewodu	Oznaczenie przyłączki	Nr katalogowy
	6	WE 6 LL R 1/8	425000006021
	6	WE 6 LL M 6x1	425000006023
	6	WE 6 LL M 8x1	425000006025
	6	WE 6 LL M10x1	425000006027
	6	WE 6 L R 1/4	425000006028
	<b>Przyłączka kątowna na przewód d 4 mm</b>		
	Średnica przewodu	Oznaczenie przyłączki	Nr katalogowy
	4	WE 4 LL R 1/8	425000006020
4	WE 4 LL M 6x1	425000006022	
4	WE 4 LL M 8x1	425000006024	
4	WE 4 LL M10x1	425000006026	
	<b>Przyłączka kątowna nastawna</b>		
	Średnica przewodu	Oznaczenie przyłączki	Nr katalogowy
	6	SWV 6 LL R1/8	425000006096
	6	SWV 6 LL M10x1	425000006097
	<b>Przyłączka kątowna nastawna</b>		
	Średnica przewodu	Oznaczenie przyłączki	Nr katalogowy
4	SWV 4 LL R1/8	425000006099	
4	SWV 4 LL M10x1	425000006098	
	<b>Złączka prosta</b>		
	Średnica przewodu	Oznaczenie złączki	Nr katalogowy
	4	G 4 LL	425000006034
	6	G 6 LL	425000006035
6	G 6 L	425706210980	
	<b>Trójnik równoprzelotowy</b>		
	Średnica przewodu	Oznaczenie trójnika	Nr katalogowy
	4	T 4 LL	425000006036
	6	T 6 LL	425000006037
	6	T 6 L	425706211001

	<b>Zawór zwrotny do rozdzielaczy progresywnych</b>		
	Średnica przewodu	Oznaczenie	Nr katalogowy
	6	A NRVT 6	42500006061
	6	B NRVB 6	425700176003
	6	C NRVL 6	425700186003
	<b>Zaślepka do rozdzielaczy progresywnych</b>		
	Gwint	Oznaczenie	Nr katalogowy
	M 10x1	CPB	430022
	<b>Złączka grodziowa prosta na przewód d 6 mm</b>		
	Średnica przewodu	Oznaczenie złączki	Nr katalogowy
	6	GVS 6 L	430000061215
	<b>Złączka grodziowa kątowa na przewód d 6 mm</b>		
	Średnica przewodu	Oznaczenie złączki	Nr katalogowy
	6	WVS 6 L	430000060362
	<b>Nakrętka</b>		
	Średnica przewodu	Oznaczenie nakrętki	Nr katalogowy
	4	M 4 LL	42500006057
	6	M 6 LL	42500006055
	<b>Pierścień zaciskowy</b>		
	Średnica przewodu	Oznaczenie pierścienia	Nr katalogowy
	4	CR 4 LL	42500006058
	6	CR 6 LL	42500006056
	<b>Szczotka smarowa okrągła</b>		
	Rodzaj szczotki	Oznaczenie szczotki	Nr katalogowy
	L / l x D / d		
	54 / 30 x 15 / 6	A OBRM	425000180006
	40 / 15 x 9 / 4	B OBRS	1140003

## Adaptery

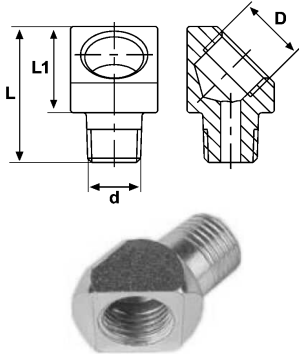
		Adapter kątowy 45						
		d	D	L	L1	SW	Oznaczenie	Nr katalogowy
		M10x1k	M 10x1	23	13	13	E411	425100100833
		M 8x1k	M 8x1	23	13	13	E488	425000006070
		R 1/8	G 1/8	23	13	13	E455	425100100844

		Adapter kątowy 90						
		d	D	L	L1	SW	Oznaczenie	Nr katalogowy
		M 6x1k	M 8x1	23	13	12	E968	425100100721
		M 8x1k	M 8x1	23	13	13	E988	425000006072
		M10x1k	M10x1	23	13	13	E911	425100100733
		M10x1k	M 8x1	23	13	12	E918	425000006073
		R 1/8	M 8x1	23	13	12	E958	425100190744
		R 1/8	G 1/8	23	13	13	E955	425100100744

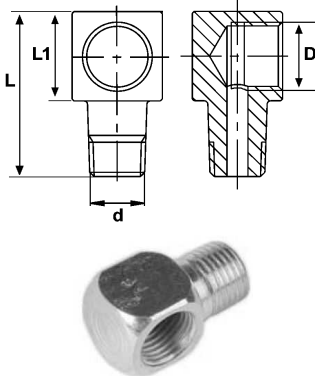

  

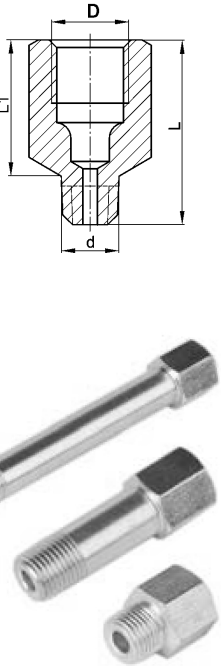

		Adapter prosty						
		d	D	L	L1	SW	Oznaczenie	Nr katalogowy
		M 6x1k	M 8x1	18	10	11	E1681	425100100120
		M 8x1k	M 8x1	18	10	11	E1881	425000006050
		M 8x1k	M 8x1	32	10	11	E1883	425100100132
		M 8x1k	M 8x1	63	10	11	E1886	425100100135
		M 8x1k	M10x1	23	11	13	E1812	425100100137
		M10x1k	M 8x1	18	10	11	E1811	425000006051
		M10x1k	M10x1	18	11	13	E1111	425000006052
		M10x1k	M10x1	23	11	13	E1112	425100100141
		M10x1k	M10x1	35	11	13	E1113	425100100145
		M10x1k	M10x1	40	11	13	E1114	425100100143
		M10x1k	M10x1	50	11	13	E1115	425100100146
		R 1/8	M 8x1	18	11	13	E1518	425100100155
		R 1/8	M10x1	18	11	13	E1511	425100100151
		R 1/8	G 1/8	18	11	13	E1551	425100100152
		R 1/8	G 1/8	23	11	13	E1552	425100100148
		R 1/8	G 1/8	35	12	13	E1553	425100100149
		R 1/8	G 1/8	50	12	13	E1555	425100100153
		R 1/4	M10x1	20	11	17	E1412	425100100144
		R 1/4	G 1/8	20	11	17	E1452	425100100147

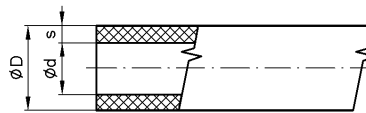

## Smarowanie ręczne

	<b>Blok smarowy</b>				
	Oznaczenie	L1	L2	L3	Nr katalogowy
	BS 1	30	20		425100100211
	BS 2	60	50	22	425100100212
	BS 3	80	70	22	425100100213
	BS 4	106	96	22	425100100214
	BS 5	128	118	22	425100100215
	BS 6	150	140	22	425100100216
	BS 8	194	184	22	425100100218
	<b>Smarowniczką kulkową DIN 71412 prosta</b>				
	Gwint	Oznaczenie		Nr katalogowy	
	M 6x1k	H1 M 6x1		425000401012	
	M 8x1k	H1 M 8x1		425000401013	
	M10x1k	H1 M10x1		425000401014	
	R 1/8	H1 R 1/8		425000401015	
	G 1/4	H1 G 1/4		425000401114	
	<b>Smarowniczką kulkową DIN 71412 kątowną 45</b>				
	Gwint	Oznaczenie		Nr katalogowy	
	M 6x1k	H2 M 6x1		425000401042	
	M 8x1k	H2 M 8x1		425000401043	
	M10x1k	H2 M10x1		425000401044	
	R 1/8	H2 R 1/8		425000401045	
	<b>Smarowniczką kulkową DIN 71412 kątowną 90</b>				
	Gwint	Oznaczenie		Nr katalogowy	
	M 6x1k	H3 M 6x1		425000401092	
	M 8x1k	H3 M 8x1		425000401093	
	M10x1k	H3 M10x1		425000401094	
	R 1/8	H3 R 1/8		425000401095	
	<b>Smarowniczką płaską DIN 3404</b>				
	Gwint	Rozmiar głowy	Oznaczenie	Nr katalogowy	
	M 6x1k	16	M1 M 6x1	425000401062	
	M 8x1k	16	M1 M 8x1	425000401063	
	M10x1k	16	M1 M10x1	425000401064	
	M12x1,5	16	M1 M12x1,5	425000401066	
	M14x1,5	16	M1 M14x1,5	425000401067	
	R 1/8	16	M1 R 1/8	425000401065	
	G 1/4	16	M1 G 1/4	425000401068	
	M16x1,5	22	M22 M16x1,5	425000401026	
	G 1/4	22	M22 G 1/4	425000401024	
	<b>Złączka grodziowa z gwintem wewnętrznym</b>				
	Gwint	Średnica przewodu		Nr katalogowy	
	M 10x1	6		425100106243	

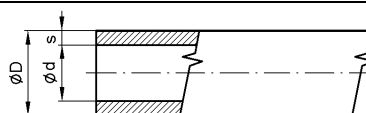
## Przewody smarowe

		Przewód PA 12 HL		
		D x s	d	Nr katalogowy
	6 x 1,5	czarny, pusty	3	425000715615
	6 x 1,5	czarny, napełniony smarem NLGI 2	3	425007715615
	6 x 1,5	czarny, napełniony smarem NLGI 000	3	425007715616
	6 x 1,5	biały, pusty	3	425100190003
	4 x 0,85	czarny, pusty	2,3	425000716485
	4 x 0,85	czarny, napełniony smarem NLGI 000	2,3	425007716485
4 x 0,85	biały, pusty	2,3	425100190006	

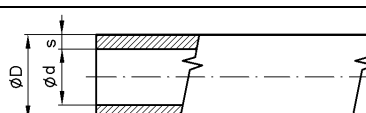
		Przewód sztywny - rurka stalowa			
		D x s	d	p <sub>n</sub>	Nr katalogowy
	6 x 1	czarny	4	390	144311601001
	6 x 1	ocynkowany	4	390	144311601010
	4 x 0,5	czarny	3	315	144311400501
	4 x 0,5	ocynkowany	3	315	144311400510
	4 x 1	ocynkowany	2	520	144311400530
	6 x 1	nierdzewny	4	430	144311601030

		Przewód giętki - rurka miedziana			
		D x s	d	p <sub>n</sub>	Nr katalogowy
	6 x 1		4	90	144312601001
	4 x 0,6		2,8	60	144312400501

		Przewód osłonowy spiralny		
		Średnica przewodu	Oznaczenie przewodu	Nr katalogowy
7 / 11	PE 7/11	283563600558		
12 / 18	PE 12/18	425100100041		

		Przewód osłonowy		
		Średnica przewodu	Oznaczenie przewodu	Nr katalogowy
10 / 13	PH 10/13	425100100030		
12 / 16	PH 12/16	425100100031		

## Przewód wysokociśnieniowy DN4

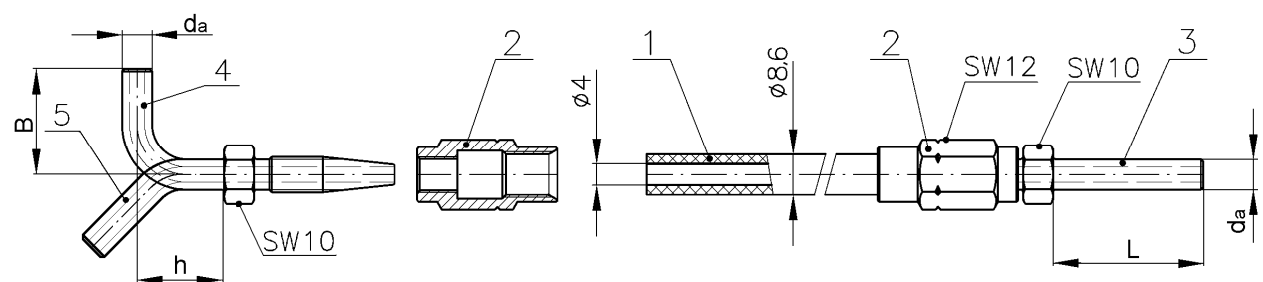



	1 Przewód wysokociśnieniowy DN4			
	Przewód	$p_n$	$p_{max}$	Nr katalogowy
	DN4 pusty	350	840	425000101000
	DN4 napełniony smarem NLGI2	350	840	425000006081

	2 Nakrętka zakuwki do przewodu DN4		
	Oznaczenie	SW	Nr katalogowy
	DN4N	12	425000006040

	3 Końcówka zakuwki prosta gładka				
	Oznaczenie	da	L	SW	Nr katalogowy
	DN414KG	4	20	10	425100140054
	DN416KG	6	20	10	425100100054
	DN416MG	6	24	10	425100100055
	DN416DG	6	30	10	425000006041
DN418DG	8	30	10	425100180051	

	3 Końcówka zakuwki prosta z rowkiem				
	Oznaczenie	da	L	SW	Nr katalogowy
	DN416KR	6	20	10	425100190054

	Końcówka zakuwki dwuzłazce			
	Oznaczenie	SW	Nr katalogowy	
	DN41C	10	425100100061	

	4 Końcówka zakuwki kątowna 90° gładka					
	Oznaczenie	B	h	da	SW	Nr katalogowy
	DN496KG	21	13	6	10	425853380003
	DN496MG	33	14	6	10	425100100059
	DN496SG	29	17	6	10	425100100062
	DN496NG	37	28	6	10	425100100053
	DN496DG	53	28	6	10	425100100056
	4 Końcówka zakuwki kątowna 90° z rowkiem					
	Oznaczenie	B	h	da	SW	Nr katalogowy
	DN496NR	37	28	6	10	425100190053
DN496DR	53	28	6	10	425100190056	

	5 Końcówka zakuwki kątowna 45° gładka					
	Oznaczenie	B	h	da	SW	Nr katalogowy
	DN446KG	15	24	6	10	425100100057
	DN446NG	25	35	6	10	425100100058
	5 Końcówka zakuwki kątowna 45° z rowkiem					
	Oznaczenie	B	h	da	SW	Nr katalogowy
	DN446KR	15	24	6	10	425100190057
	DN446NR	25	35	6	10	425100190058

## Przewód wysokociśnieniowy DN6

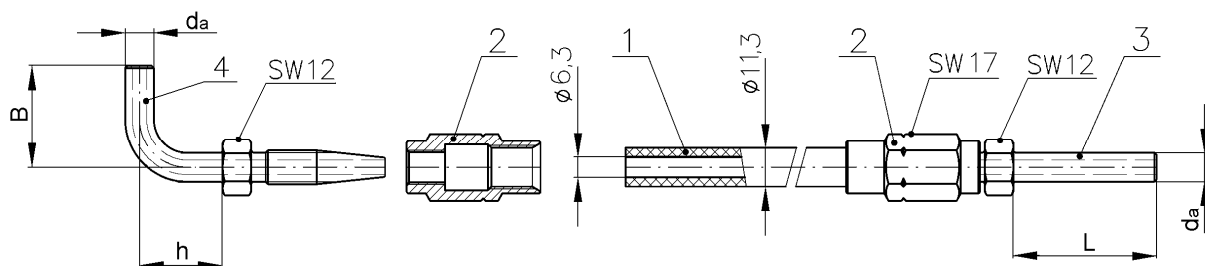

### 1 Przewód wysokociśnieniowy DN6

Przewód	$p_n$	$p_{max}$	Nr katalogowy
DN6 pusty	350	840	425100101006
DN6 napełniony smarem NLGI2	350	840	425100100011



### 2 Nakrętka zakuwki do przewodu DN6

Oznaczenie	L	SW	Nr katalogowy
DN6N	36	17	425100100060

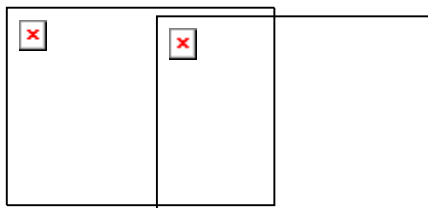

### 3 Końcówka zakuwki prosta gładka

Oznaczenie	$d_a$	L	SW	Nr katalogowy
DN616G	6	20	12	425100100064
DN618G	8	20	12	425100100074

### 3 Końcówka zakuwki prosta z rowkiem

Oznaczenie	$d_a$	L	SW	Nr katalogowy
DN616R	6	20	12	425100190064



### 4 Końcówka zakuwki kątowna 90° gładka

Oznaczenie	B	h	$d_a$	SW	Nr katalogowy
DN696G	45	22	6	12	425100100063
DN698G	36	23	8	12	425100100073



### 2 + 3 Zakuwka prosta gładka - komplet







Oznaczenie	$d_a$	L	Nr katalogowy
DN610G	10	21	425100141146

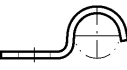

### 2 + 4 Zakuwka kątowna 90° gładka - komplet

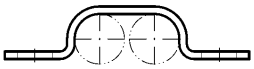
Oznaczenie	B	h	$d_a$	Nr katalogowy
DN690G	42	12	10	425100141162

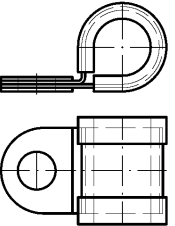
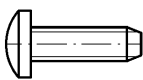
## Mocowania przewodów

	<b>Uchwyt przewodu x 1 / 1</b>		
	Średnica przewodu	Oznaczenie uchwytu	Nr katalogowy
	4	TC141	425200100004
	6	TC161	425200100006
	8	TC181	425200100008
	<b>Uchwyt przewodu x 2 / 1</b>		
	Średnica przewodu	Oznaczenie uchwytu	Nr katalogowy
	4	TC241	425200210004
	6	TC261	425200210006
	8	TC281	425200210008
	<b>Uchwyt przewodu x 2 / 2</b>		
	Średnica przewodu	Oznaczenie uchwytu	Nr katalogowy
	4	TC242	425200200004
	6	TC262	425200200006
	8	TC282	425200200008
	<b>Uchwyt przewodu x 3</b>		
	Średnica przewodu	Oznaczenie uchwytu	Nr katalogowy
	4	TC34	425200300004
	6	TC36	425200300006
	8	TC38	425200300008
	<b>Uchwyt przewodu x 4</b>		
	Średnica przewodu	Oznaczenie uchwytu	Nr katalogowy
	4	TC44	425200400004
	6	TC46	425200400006
	8	TC48	425200400008
	<b>Uchwyt metalowo gumowy</b>		
	Rozmiar uchwytu	Oznaczenie uchwytu	Nr katalogowy
	6	TR6	425000006105
	8	TR8	425000006106
	10	TR10	425000006107
	12	TR12	425000006108
	15	TR15	425000006109
	18	TR18	425000006110
	20	TR20	425000006111
	22	TR22	425000006112
	25	TR25	425000006113
28	TR28	425000006114	
	<b>Śruba mocująca</b>		
	Rodzaj śruby	Oznaczenie	Nr katalogowy
	M5x13 samogwintująca	TS0513	309335504813
	M4x12 samogwintująca	TS0412	309275050012
	<b>Opaska zaciskowa</b>		
	Rozmiar opaski	Oznaczenie	Nr katalogowy
	2,6 x 200	GP20	430008180156
	2,6 x 280	GP28	430008180157